

Metso

Taking your grinding to the next level

Mill lining solutions for horizontal mills

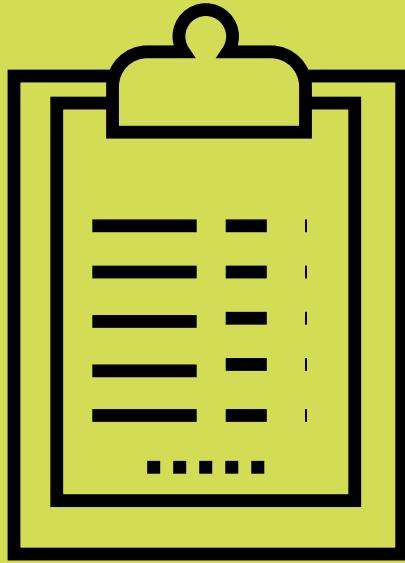



Do these challenges look familiar?



Get more from your mill liners

As you strive to achieve better grinding performance and profitability, the liners used in your mill greatly influence the outcome. Familiar challenges can include having low mill capacity due to non-optimal liner design or experiencing excessive downtime due to unbalanced liner wear life. Liner change-outs can be difficult and carry safety concerns, leading to less uptime. In addition, you may feel you are not getting the right expertise when you need it.

With Metso mill lining solutions, we help you overcome these challenges. We have years of experience in designing, manufacturing, delivering and optimizing mills and liners, so we know how to get the most from your grinding process. By installing our mill liners, you benefit from a full service and maintenance offering that meets your individual needs.

Unlock value and keep your grinding process rolling

Our liners are used in more than 4,000 mills around the world, and we have the experience to deliver consistent value to our partners through our long-term service agreements.

Being a grinding mill OEM supplier, we know inside and out how mills work and how to best design liners to fit your specific conditions.

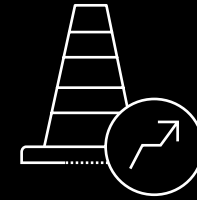

Improved safety through mill liner design, installation methods and modern tools



Reduced total cost of operation through longer wear life and optimized maintenance cycles

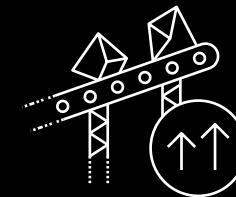

Maximized throughput by optimizing change-outs, mill lining design and material

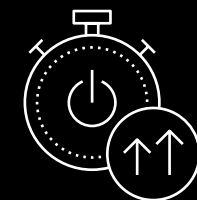

Fewer and shorter maintenance stops and more balanced maintenance cycles

Widest offering - by far

Together towards continuous improvement

Full offering of innovative solutions



All types of mill linings

No other mill lining supplier has as wide a product range as Metso. Different lining types can also be combined in the same mill to achieve optimal performance.

- Metallic mill linings
- Skega Poly-Met™ mill linings
- Skega™ rubber mill linings
- Orebed™ mill linings
- Megaliner™

Liners for all types of mills

Our state-of-the-art linings are available for mills of virtually all types, sizes and brands.

- Semi-autogenous mills
- Fully autogenous mills
- Ball mills
- Rod mills
- Pebble mills
- Continuous mills
- Batch mills

Covering all sections within a mill

- Head linings
- Shell linings
- Discharge systems
- Trunnion linings
- Mill trommel screens

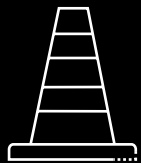

Safety

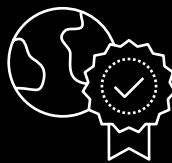

Sustainability

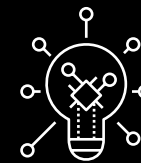

Innovation



Value-added services

Shutdown services

- Planning
- Supervision
- Execution
- Optimization

Process optimization services

- Grinding optimization studies
- Controls and sensors

Grinding mill services

- Inspections
- Spares and upgrades
- Recycling of worn liners (selected markets)

Reline machines

Efficient and safe change-outs with our reline machines.

New mills and other equipment

Customized as well as pre-engineered robust mills and a full range of other process equipment.



Partnering for performance

Mill lining contract services

Close collaboration means better results.

- Supply agreements
- Consignment inventory
- Life cycle services
- Payment models

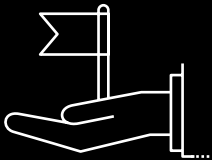

Local support and global expertise



Proven track-record

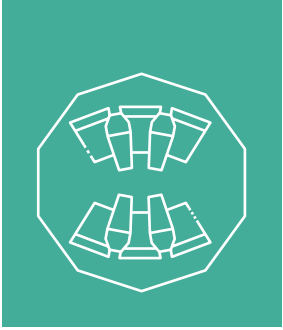

Different materials offer unique advantages

Metallic mill linings

Metallic mill linings are the traditional linings familiar to most mines. Our Cr-Mo steel and high-chromium white iron linings are specifically developed for mill lining applications and are carefully selected based on the operating conditions of each mill. Liners are designed for maximum performance and minimized replacement time.



We made the world's largest liners, weighing 8 tons

Poly-Met mill linings

The Skega Poly-Met™ concept combines the most desirable properties of rubber and steel to maximum advantage. Compared to conventional metallic linings, harder and more wear-resistant alloys of iron and steel can be used, as the rubber substantially dampens the impact forces.



Low weight and long wear life

Rubber mill linings

Impact resistant and lightweight Skega™ rubber mill linings were first pioneered by Metso over 60 years ago. The grades of wear-resistant rubber can be used for specific operating conditions in all types of mills. Each grade is based on the experience of thousands of real-world applications.



Lightweight for safe and easy handling

Orebed mill linings

The Orebed™ magnetic lining system consists of a series of powerful permanent magnets embedded within a matrix of highly abrasion-resistant rubber. Magnetic force ensures that the lining attracts the ferromagnetic material in the mill load, forming a continuous, self-renewing wear layer with a wave profile.



Lining stays in place with constant performance for years

Megaliner

The innovative Megaliner™ concept was created to reduce downtime and improve safety during relines. A Megaliner element integrates multiple lifter and plate rows and has a minimum number of attachment points. Covering an area several times larger than conventional liners, these liners are lightweight in relation to their size.

Megaliner is now available for all sections of horizontal mills: the head, the shell and the discharge system. The concept is best suited for large AG, SAG and ball mills with large trunnions and where modern liner handlers are available.

Speeds up
installations
by up to 40%



Unique attachment system:
the liner bolts are inserted and
removed from the outside of the
mill, minimizing the number of
parts and people inside the mill.



Combine for better results

Our ability to combine different liner materials inside the same mill and in different sections enables us to further optimize your grinding process. Using each lining material where it performs the best makes it possible to achieve results, such as energy savings by reducing the mill's overall weight, balanced wear life for synchronized maintenance intervals and minimized risk for cracking and pegging. To enable this agility and adaptability, our own product engineering and production teams are essential. This is what sets Metso apart from the rest.

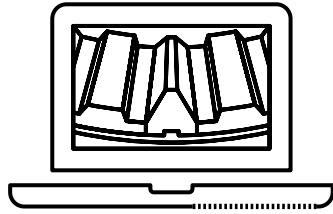

Custom designed

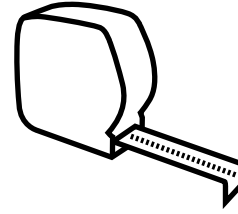

Adaptable



Perfect fit

Application examples

Rubber or composite discharge systems reduce weight in metallic-lined mills

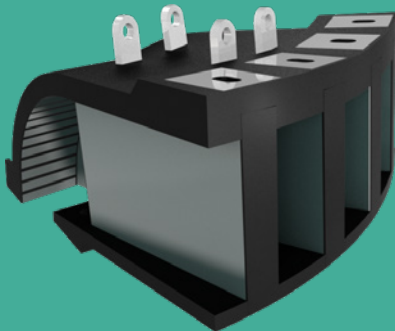

Metallic grate plates combined with Poly-Met™ offer a balanced wear solution for large mills

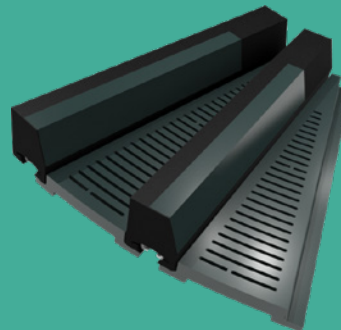

Poly-Met™ shell plates combined with metallic lifter bars minimize cracking in large SAG mills

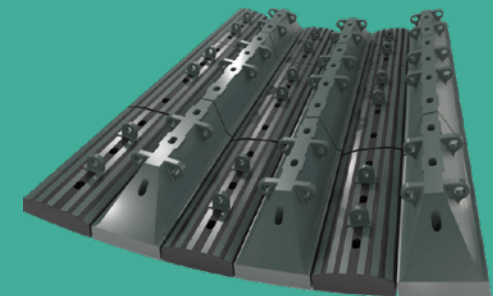

Covering
all sections
within a mill

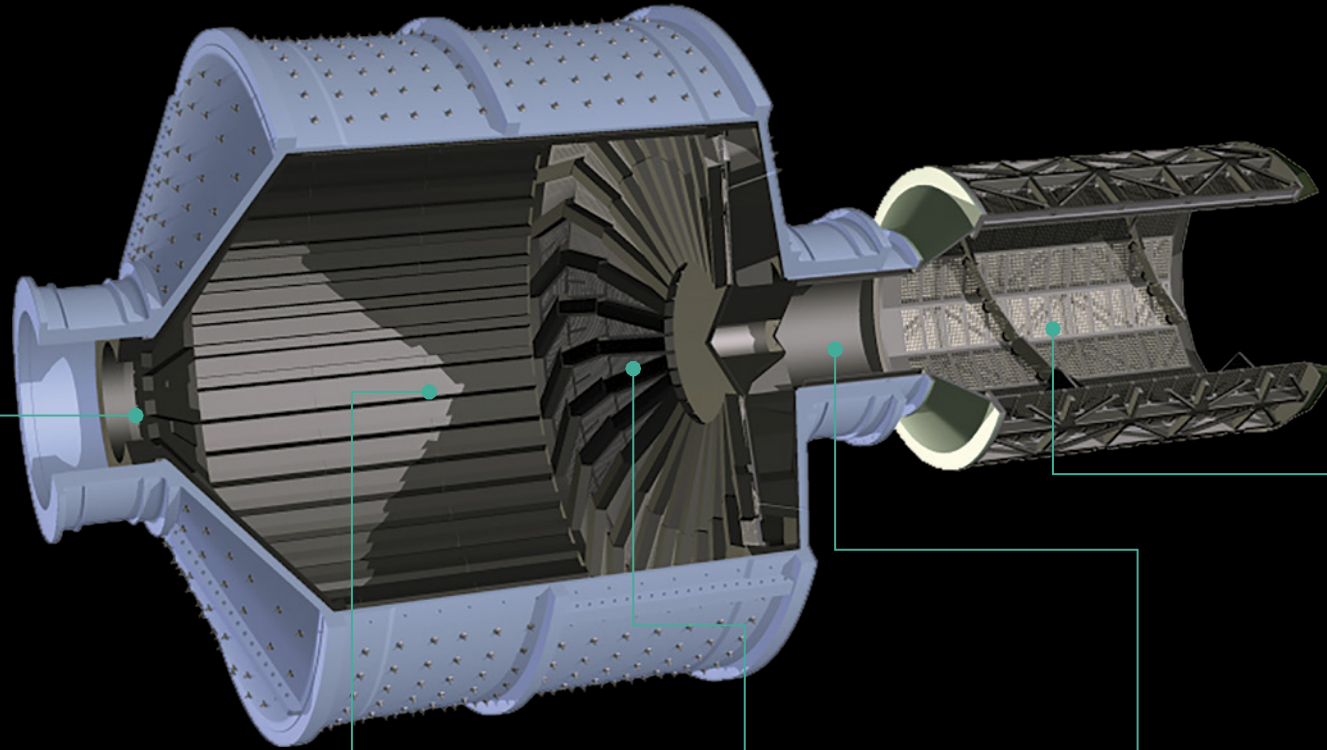

Head linings

A balanced feed head lining design minimizes downtime.

The feed-head lining is designed with consideration to the shell lining design. All components must be in balance to minimize the number of maintenance stops. The number of individual parts is kept to a minimum for easy installation. A wide selection of optimized profiles and the possibility to mix all different types of lining materials gives you additional flexibility.

Shell linings

Long wear life and balanced design to maximize mill availability.

The shell lining has a major influence on grinding efficiency. It transforms the mill rotation into charge motion, and both profile and spacing must be selected to suit each specific mill. When designing a shell lining, the type of ore, mill size and speed, maintenance schedules, safety, impact levels and efficient use of materials should all be considered.

Discharge systems

Maximal throughput while minimizing back flow.

Our wear-resistant, rubber-covered or cast dischargers come in two general designs – radial and curved. Solutions that suit both trunnion overflow and grate discharge mills are made of lightweight rubber parts or heavy-duty steel parts or combinations of both, depending on customer objectives. The latest innovations, like Megaliner™ and Spiral Turbo Pulp Lifter, increase efficiency.

Trunnion linings

Durability for the mill feed and discharge ends.

Trunnion liners are custom-made to protect your mill trunnions from internal wear. Fit is critical, and our trunnion liners can be made to almost any size or shape. Our trunnion liners are grouped into three categories: one-piece, replaceable sleeve and bolted wear elements.

Mill trommel screens

Lets you control the true discharge size efficiently.

Mill trommels, whether used for sizing or scalping, play a vital role in your grinding circuit. Our robust but lightweight frames consist of carefully selected welded profiles that are covered in a protective layer of wear-resistant rubber or polyurethane. Smartly designed deflectors for feeding ore optimally to the screening surface can be used to further increase efficiency and capacity.



Drive your development forward with our value-added services

Improve your operational efficiency, reduce risks and increase profitability by utilizing our unique knowledge, experienced people and innovative solutions. We provide spare parts, installations and a full set of advanced tools to simplify maintenance, improve safety and optimize operations.

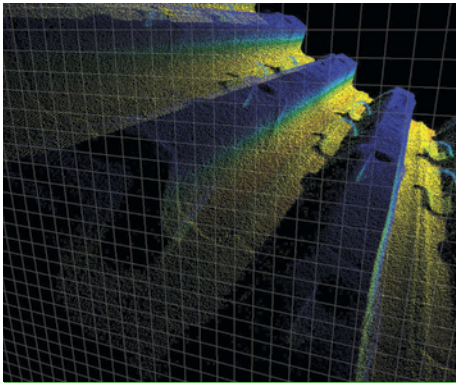

Wear reading solutions

Wear monitoring is the key to constant improvement and optimized performance.

We offer:

- Traditional wear readings
- Expert observations
- iPad tool that captures profiles and images
- MillMapper™ patented 3D wear scanning

Combining different methods is often very efficient.



Shutdown services

Successful and safe shutdowns require thorough planning, optimized liner design, reliable installation methods and careful monitoring to achieve the least amount of downtime.

We offer:

- Planning
- Supervision
- Execution
- Optimization



Process optimization services

With the goal to maximize efficiency and profit, we offer a complete range of process optimization tools and services.

We take a holistic view to your process and optimize to find exactly the right balance to get the most out of your process.

We offer:

- Grinding optimization
- Controls and sensors



Grinding mill inspections

Mill issues that are not caught early can lead to breakdowns and unplanned downtime, significantly increasing repair costs and production losses. Our inspection services have you covered.

We offer fit-for-purpose inspection packages for improved mill reliability, integrity and longevity.



Spares and upgrades

Quality spares and a wide variety of upgrades to get your mill performing like a modern-day machine.

- Improve safety
- Ramp up capacity
- Increase equipment life
- Simplify and speed up maintenance
- Improve energy efficiency
- Better reliability



Reline machines

Upgrading your liner handler and liners to optimize future relines is a quick return on investment. Our liner handlers provide the highest level of safety and are the most powerful machines in the industry with a capacity of up to 6,000 kg.

We offer:

- 7-axis reline machines
- Tube reline machines
- Feed chute transporters
- Bolt hammers



New mills and other equipment

To get the most out of your process, you may need to upgrade your equipment. We know both mills and liners and can help you select equipment that not only operates efficiently today, but is also equipped to handle the liner and maintenance needs of the future.

We offer:

- Premier™ customized mills
- Select™ pre-engineered mills
- Stirred mills, chutes and a full range of other process equipment

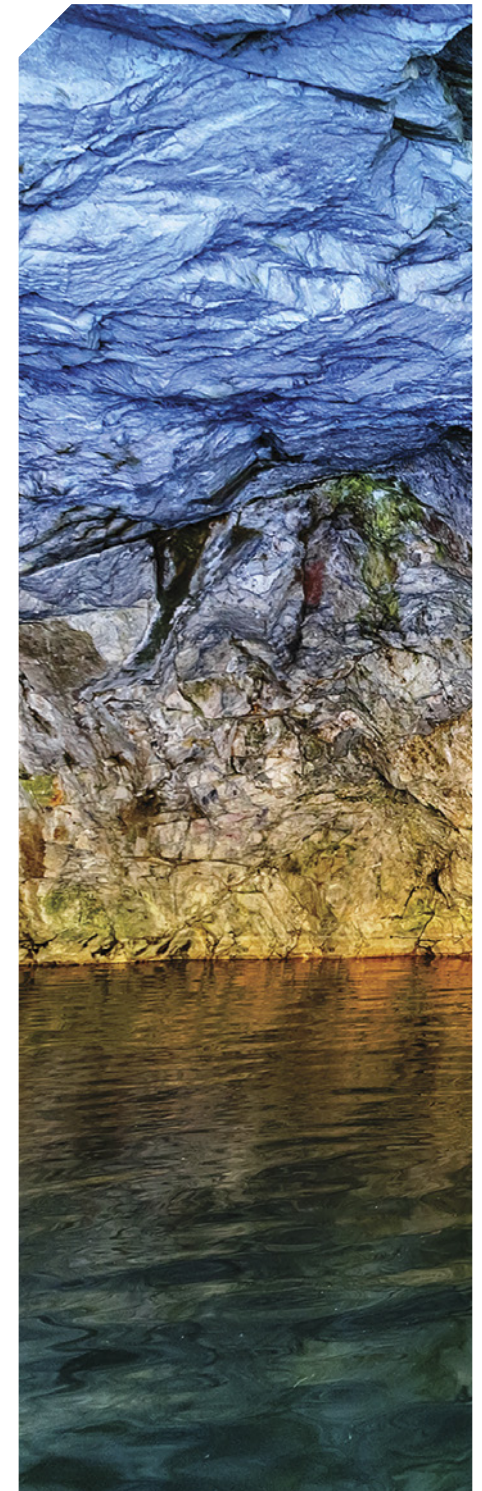



Using data to your benefit

The value of data lies in how it is used. Even if you discover the most incredible insights in your grinding process data, they won't matter unless they are actionable. These actions then increase maintenance efficiency, improve availability, lower maintenance costs and help you reach your sustainability targets.

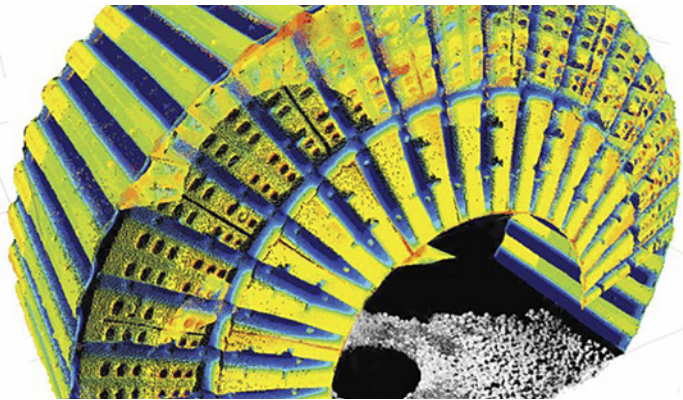

Understand how a mill liner wears

MillMapper™ is the patented industry standard in mill liner condition monitoring and 3D modeling. It empowers your maintenance and operational personnel to extend liner life cycles, prevent liner failures, optimize throughput and improve the performance of your mill.

The intelligent software tracks and forecasts wear on your shell, discharge and feed end liners, providing accurate information on mill charge and a wide range of metallurgical parameters.

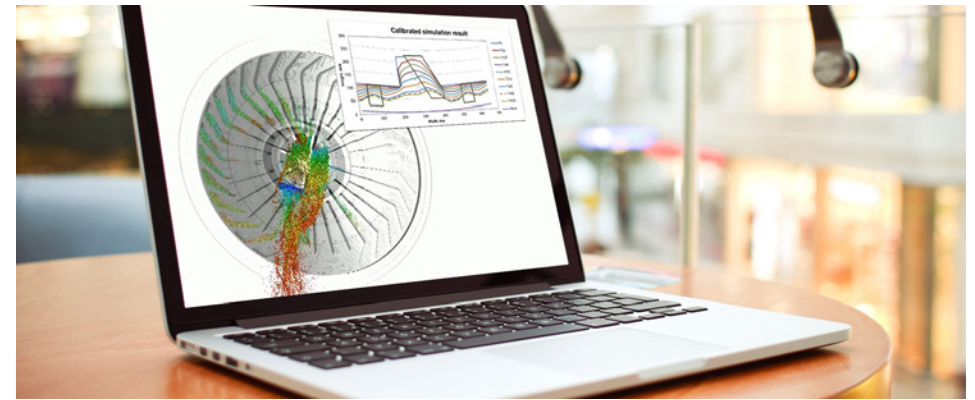

Get failure-resistant, longer-lasting liners

Instead of using the general discrete element modeling (DEM) software available on the market, we have developed our own set of simulation software that uses algorithms created based on our vast grinding process know-how.

The unique wear-progression model predicts the performance of the lining extremely accurately and can be calibrated using wear-monitoring data to further optimize the liner design. It is the market's most advanced software for comparing different lining alternatives and calculating total costs over lining life cycles.

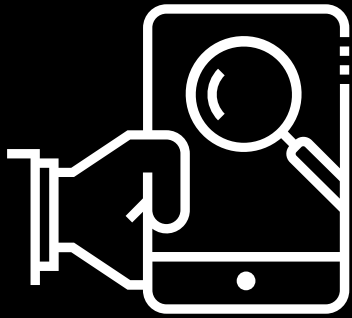

With optimized liner design and maintenance procedures, we can shorten each shutdown and also prolong the time between them, resulting in more uptime, increased sustainability and a safer operation.



Optimize your grinding circuit

The comminution circuit has many different elements that can make it challenging to choose the correct operating and control strategies. We have data-driven tools and the expertise to increase throughput and availability to reduce energy consumption in your circuit.

Our specialists use ore characterization data, comprehensive plant surveys and historical operational data to develop site-specific models, used in simulation studies. Combining this with our benchmarking data, areas of improvement and their priorities can be identified and addressed.



Assess shutdown performance

Frequently used by our customers, a Single Minute Exchange of Dies (SMED), or time and motion analysis, uses time-lapse videos to examine relining. Cameras are strategically positioned to capture the entire process. Maintenance and reline experts analyze the video sequences to highlight issues and recommend improvements for speeding up wear parts change-outs.

By having documented information on shutdowns and the time taken for key tasks, your planners have the tools to create better shutdown duration estimates and timelines.



Partnering for performance

As your partner in maximizing performance, we are fully committed to helping you optimize your mill throughput and drive down your total costs. That means providing you with reliable products and valuable services. Every mill is unique, and their operating conditions continually change over time. Continuous optimization means that we work closely with you to truly understand your process and make agreed improvements. We take a step-by-step approach, capture improvement changes and evolve together, so you can be sure that you'll always have the ideal lining and services.

Did you know?

Meiso has experience from over 500 long-term contracts, where we have successfully helped our customers reach their targets.

Partnering with us gives you thorough audits, liner design, technical support, wear follow up and constant liner improvements.



Mill lining contract services

To ensure optimum performance of your grinding operations, you may want to consider a service contract that is designed to give you peace of mind. Depending on the scale of your needs, our service contracts are equipped to cover a single reline event or to span multiple years. A long-term commitment with mutually agreed targets facilitates optimization, allowing you to achieve more in terms of safety, sustainability, uptime and throughput. We get to know your site, process and targets on a deeper level, which leads to better results.

	Scope	Results
Supply contract for several liner sets	A long-term commitment with mutually agreed targets facilitates optimization, allowing us to achieve more	<ul style="list-style-type: none"> • Optimized liners based on your operating conditions • Secured supply • Simplified procurement
Inventory contract	Metso owned inventory – a lining with the latest design or a safety lining in stock	<ul style="list-style-type: none"> • A customized spare lining always on hand • Reduced risks • Inventory optimization
Life cycle service contract	A customized agreement including the services and parts of your choice to meet your specific needs and targets	<ul style="list-style-type: none"> • Secured improvements on your selected KPIs • Expert support for maximized profit • Convenience and reliability



Different payment solutions:
price per set,
performance pricing, fixed
monthly fee
or cost-per-ton.

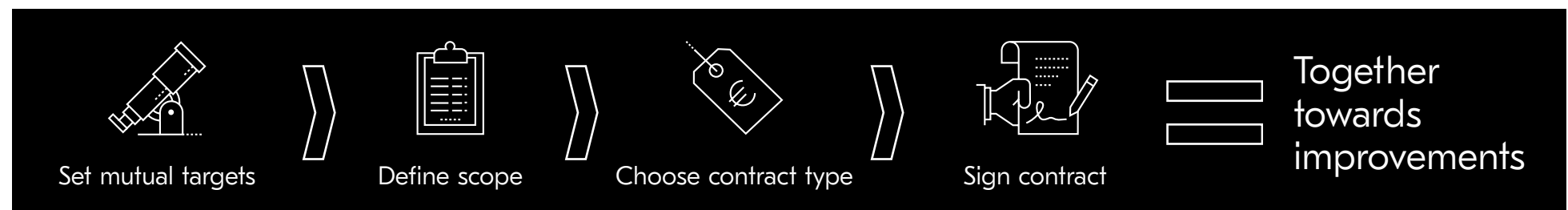



Empowering safe work

As your partner in mill linings, we are fully committed to helping your operations reach the safety targets. That means providing you with innovations that make the relining process safer, faster and more efficient. The safety of the relining crew comes first. Installations can be carried out in a safer way with smartly designed, easy-to-handle components that are faster to change and have a perfect fit.

Did you know?

Megaliner™ mill liners have a unique attachment system. Liners placement is done by the liner handler operator alone and the bolts are inserted from the outside of the mill. This invention has made a great difference in worker safety.



How we improve relining safety?

- All wear parts are designed with safety as a top priority
- Our safe work procedures and solutions are designed to avoid having workers in hazardous environments
- Fewer pieces and up to 40% faster installations mean shorter shutdowns
- Long wear life reduces the need for risky maintenance = fewer shutdowns

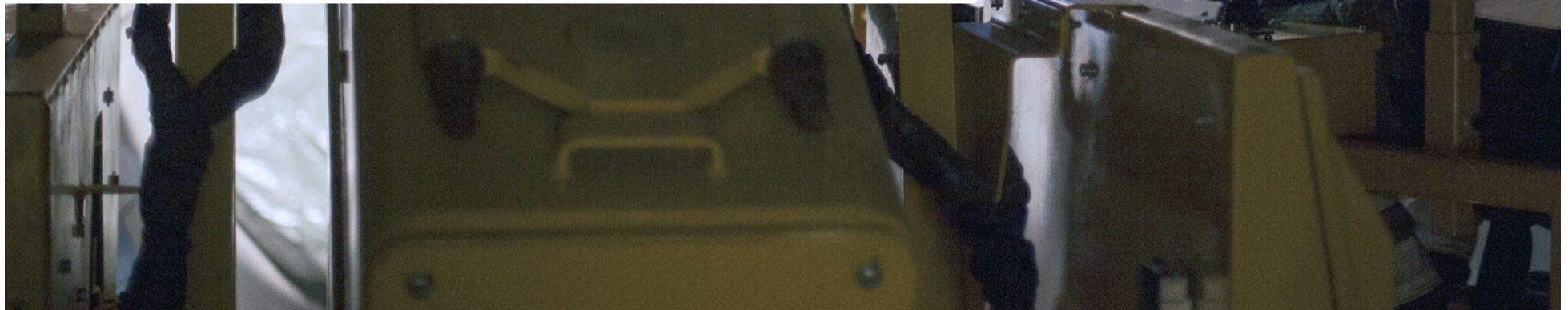



Sustainability values

There is enormous demand for environmental efficiency in the mining industry. By selecting Metso as a partner for optimized wear parts, not only do you get more out of your process, you also contribute to a more sustainable future.

Did you know?

Long-lasting liners significantly reduce CO₂ emissions because less products need to be manufactured and transported. Optimized liners make your process more efficient.



Sustainable offering and innovations	Responsible and trusted partner
<ul style="list-style-type: none"> • Mill linings designed to last and optimized so you can produce more with less • Dischargers can be refurbished to prolong service life • Metallic linings are not painted • No harmful substances in our rubber • Recycling of worn liners (selected markets) 	<ul style="list-style-type: none"> • We reuse steel and can recycle worn liners • Several of our factories use 100% renewable energy sources • Optimized transportation routes and logistics • In technology development, we focus on increasing resource efficiency • Responsible procurement



Planet Positive

Our recycling services solve the problem of disposing worn and used mill liners. Instead of being sent to a landfill, worn liners can be recycled and reused, helping you to reduce CO₂ emissions.

Read more about our Mill liner recycling service



Mill liner recycling service



Less material

sent to landfill and recovery of usable materials



Peace of mind

and easiness



Reduced CO₂

emissions and improved environmental efficiency

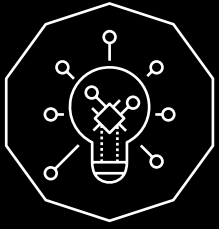

Innovation in action

Developing new materials and solutions together with our customers is at the heart of what we do. More than six decades of experience in engineering and manufacturing grinding mills, liners and surrounding process equipment has given us unique know-how.



Full Megaliner™ range



Liner Positioning System

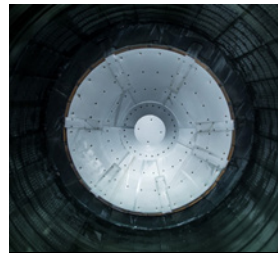

Trommel deflector

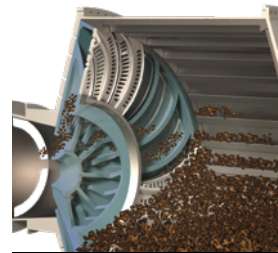

Turbo Pulp Lifter



New alloys and compounds



Patented 3D wear scanning

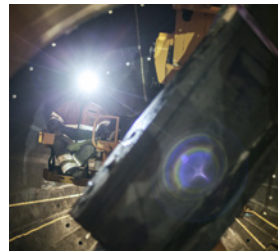

The world's largest liners

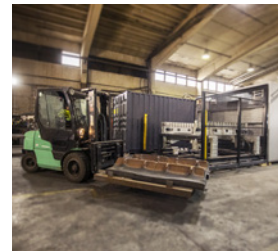

Mill lining recycling

More than

60

years of pioneering developments

...and more will come to help you stay ahead of the game!

Pioneering innovations:

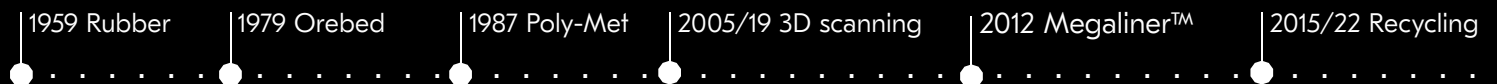



Always ready to serve you

Cooperation with our customers and availability to provide support and service are of key importance. We have local support close to our customers, several expertise hubs, as well as research facilities focused on mill lining development.

Our liners are manufactured in Metso's own global factory network, utilizing the latest technologies and adhering to stringent quality standards.

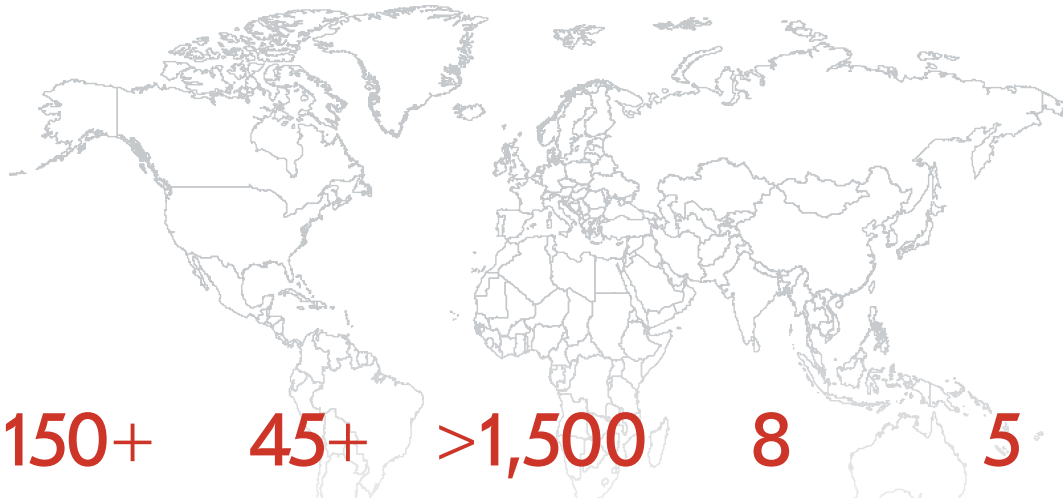

Years of expertise in mining and metal

Countries with local sales and service offices

Field technicians providing rapid response time

Factories for rubber and Poly-Met linings

Foundries for metallic linings





Case: B2Gold, Philippines

B2Gold Masbate mine increased throughput by 33%

Challenge

B2Gold's goldmine in Philippines wanted to raise their annual production target from 6 to 8 million tons while setting out to maintain the same 2.4 complete mill relines per year.

Solution

A Life Cycle Services (LCS) contract and a unique mill lining design for the SAG mill, backed up with a well-defined optimization plan and regular scans and monitoring of the wear rate of the liners. By combining different materials, such as steel, Poly-Met, rubber and ceramics, the individual liner components could be positioned in high, medium and low impact grinding zones for optimal wear life.

Results

- 33% improvement in throughput
- Increased mill uptime; most parts of the lining lasted for 4.6 million tons, which works out to about seven months
- Fewer maintenance stops
- Significant improvements in wear life of the lining



"Metso is the only one who can supply the mill lining solution we want – from the mill lining design, engineering team and service team, together with a competitive price – and these factors determined our choice of supplier. Others simply do not have a design team with that in-depth engineering knowledge."



Case: Boliden Aitik, Sweden

Liner change-out time reduced by 30% at Boliden Aitik

Challenge

Boliden's copper mine in Sweden strives for high efficiency, and creating safe workplaces for all employees is their highest priority. They wanted fewer and shorter maintenance shutdowns.

Solution

For many years they've had a Life Cycle Services (LCS) cost-per-ton agreement for mill linings and additional services and optimization. The two 38'x45' AG mills have Megaliner™ linings for the shell and feed-end head, as well as in the discharge end — a first installation in the world — for maximum uptime and safety.

Results

- Shell liner change-out time reduced by 30% compared to conventional liners
- Mill availability is ~98%, and improvement continues
- Improved safety since no personnel have to be in the danger-zone of the liners during installation or replacement
- Thanks to more balanced wear life, shutdowns dropped from 6 down to 2-3



"Our cost-per-ton agreement for mill linings makes development beneficial both for us and Metso. The agreement strengthens our cooperation, as we challenge and drive the development together."

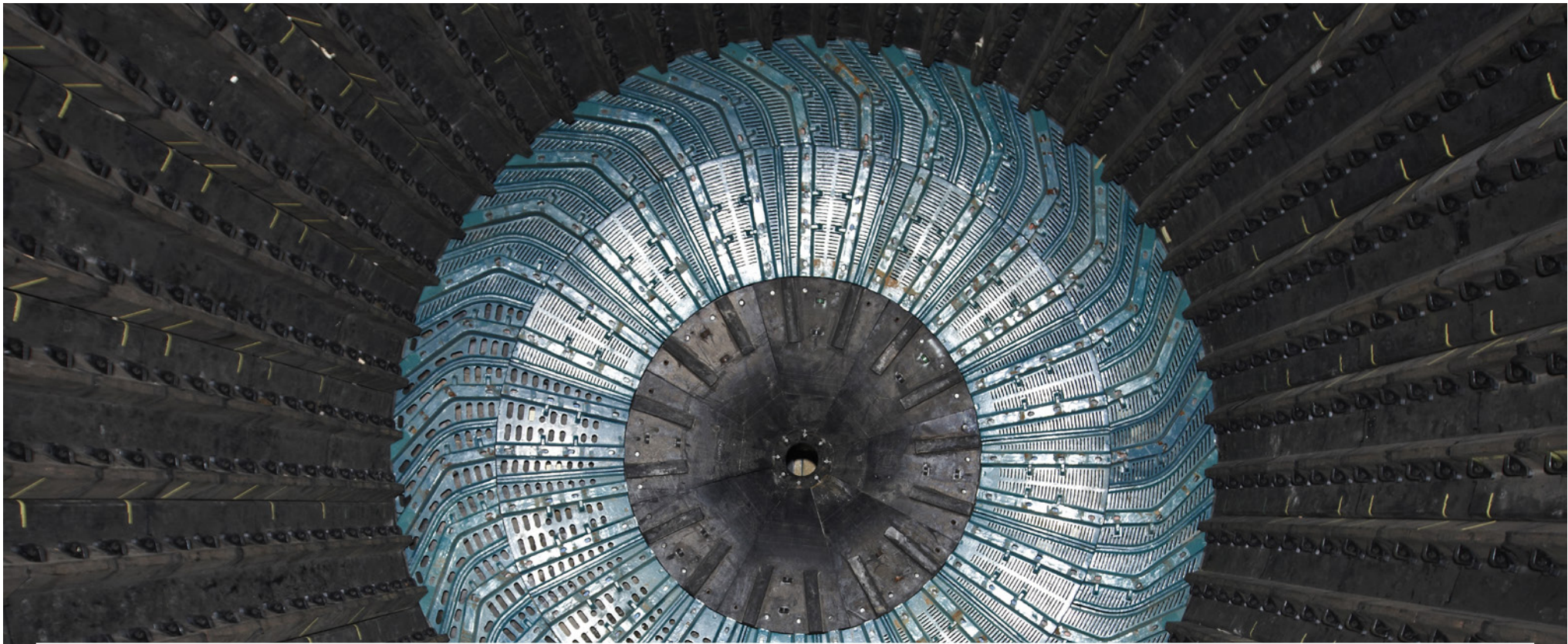

Taking your grinding process to the next level

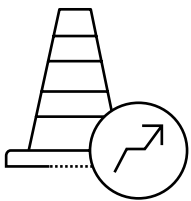

Improved
safety

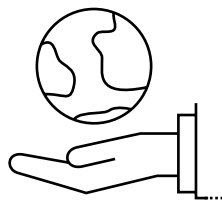

More
sustainable
operations

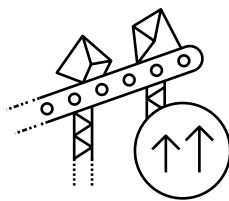

Optimized
throughput

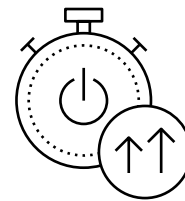

Increased
uptime

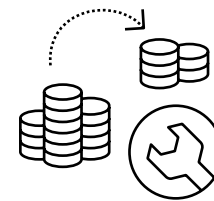

Lower cost
of operation

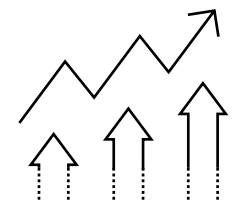

Higher
performance
and more
profit



Visit our website →

metso.com/mill-liners



Read our blog posts →

Explore expert articles for tips and insights that can help you to improve your operations



Read our case studies →

See how our customers around the world have achieved success



Subscribe to product news →

Get the latest Metso news and releases to your inbox



